

NANTUCKET TM
BREEZE

PORTABLE AIR CONDITIONER

OWNER'S MANUAL

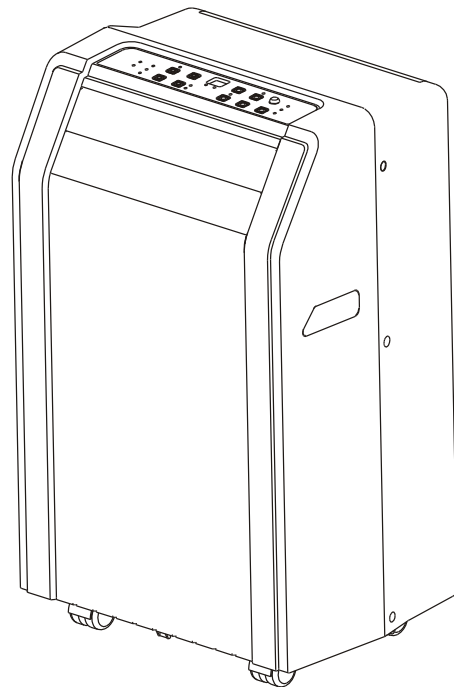

MODEL:NB10RC

SERVICE NUMBER (1-866-277-7878)

Before operating this product, please read the instructions carefully and save this manual for future use.

Read This Manual

Inside you will find many helpful hints on how to use and maintain your air conditioner properly. Just a little preventive care on your part can save you a great deal of time and money over the life of your air conditioner. You'll find many answers to common problems in the Troubleshooting Tips section (page 15).

CAUTION

- This appliance is not intended for use by children or persons with reduced physical sensory or mental capabilities, unless they are supervised by a responsible adult or considered capable enough to operate the appliance safely.
- Children should be supervised to ensure that they do not play with the appliance.
- If the supply cord is damaged, it must be replaced by the manufacturer, its service agent or similarly qualified persons in order to avoid a hazard.
- The appliance should be installed in accordance with national wiring regulations.
- Do not operate your air conditioner in a wet room such as a bathroom or laundry room.
- The appliance with electric heater should not be near any combustible materials.
- Contact the authorised service technician for repair or maintenance of this unit or have problems installing the unit.

CONTENTS

SAFETY PRECAUTIONS

Safety rules	2
Operating conditions	2
Electrical information	3

PARTS IDENTIFICATION

Included accessories	3
Name of parts	4

AIR CONDITIONER FEATURES

Control panel operating instructions	5
--	---

OPERATING INSTRUCTIONS

Operating instructions	6
------------------------------	---

INSTALLATION INSTRUCTIONS

Placement	8
Window kit installation	8
Exhaust hose installation	12
Water drainage	13

CARE AND MAINTENANCE

Care and maintenance	14
----------------------------	----

TROUBLESHOOTING TIPS

Troubleshooting tips	15
----------------------------	----

SAFETY PRECAUTIONS

Safety rules

To prevent injury to the user or other people and property damage, the following instructions must be followed. Incorrect operation may cause harm or damage.

Always do this

- Your air conditioner should be protected from moisture. e.g. condensation, splashed water, etc. Do not place or store your air conditioner where it can fall into water or any other liquid. Unplug immediately.
- Always transport your air conditioner in a vertical position and place on a stable, level surface during use.
- Turn off the product when not in use.
- Always contact a qualified person to carry out repairs. If the supply cord is damaged it must be repaired by a qualified repairer.
- Keep an air path of at least 12 in. all around the unit from walls, furniture and curtains.
- If the air conditioner is knocked over during use, turn off the unit and unplug immediately.

Never do this

- Do not operate your air conditioner in a wet room such as a bathroom or laundry room.
- Do not touch the unit with wet or damp hands or when barefoot.
- Do not press buttons with anything other than fingers.
- Do not remove any fixed covers. Do not use this appliance if it is not working properly, or if it has been dropped or damaged.
- Never use the power plug to turn unit on or off.
- Do not cover or obstruct the inlet or outlet grilles.
- Do not use hazardous chemicals to clean or come into contact with the unit. Do not use in the presence of inflammable substances or vapor such as alcohol, insecticides, gasoline, etc.
- Do not allow children to operate the unit unsupervised.
- Do not use this product for functions other than those described in this instruction manual.

Energy Save

- Use the unit in the recommended room size.
- Place the unit where nothing can obstruct the air flow.
- Keep blinds/curtains closed during the sunniest part of the day.
- Keep the filters clean.
- Keep doors and windows closed to keep cool air in and warm air out.

Operating conditions

- The air conditioner must be operated within the temperature range indicated below:

MODE	ROOM TEMPERATURE
COOL	17°C(62°F)~35°C(95°F)
DRY	13°C(55°F)~35°C(95°F)
HEAT (heat pump type)	5°C(41°F)~30°C(88°F)
HEAT (electrical heat type)	≤30°C/88°F

Note: Performance may be reduced outside of these operating temperatures.

Suggested tools for window kit installation

1. Screwdriver(medium size Phillips)
2. Tape measure or ruler
3. Knife or scissors
4. Saw(In case the window kit needs to be cut for the window to fit for direct installation)

PARTS IDENTIFICATION





▲ WARNING For your safety

- Do not store or use gasoline or other flammable vapors and liquids in the vicinity of this or any other appliance.
- Avoid fire hazard or electric shock. Do not use an extension cord or an adaptor plug. Do not remove any prong from the power cord.

▲ WARNING Electrical Information

- Be sure the power requirement is adequate for the model you have chosen. This information can be found on the serial plate, which is located on the side of the cabinet and behind the grille.
- Be sure the air conditioner is properly grounded. To minimize shock and fire hazards, proper grounding is important. The power cord is equipped with a three-prong grounding plug for protection against shock hazards.
- Your air conditioner must be used in a properly grounded wall receptacle. If the wall receptacle you intend to use is not adequately grounded or protected by a time delay fuse or circuit breaker, have a qualified electrician install the proper receptacle.
- Ensure the receptacle is accessible after the unit installation.

INCLUDED ACCESSORIES

PARTS	PARTS NAME	QUANTITY
	Exhaust hose(supplied),adapter B and Window Slider Kit and bolt (※)	1 set
	Foam seal (※)	3/pc
	Remote Controller and Battery (For remote control models only)	1set
	Drain hose	1pc

NOTE: Optional parts(※), for some models only.

- Check all the accessories are included in the package and please refer to the installation instructions for their usage.

NOTE: All the illustrations in this manual are for explanation purpose only. Your air conditioner may be slightly different.

PARTS IDENTIFICATION

NAME OF PARTS

Front

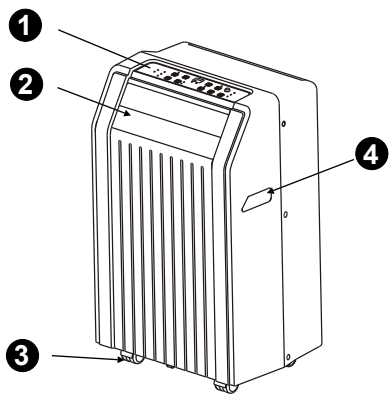

Fig.1

Model A

- 1 Control Panel
- 2 Horizontal Louver Blade (swings automatically)
- 3 Caster wheels
- 4 Carrying Handles (on each side)

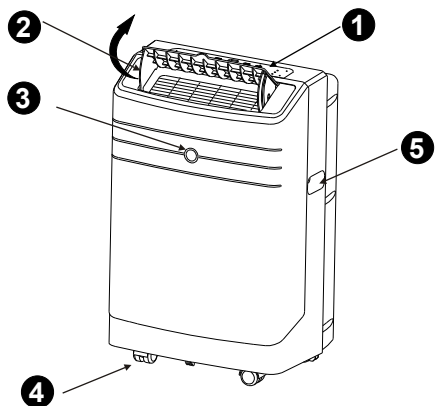

Fig.2

Model B

- 1 Control Panel
- 2 Horizontal Louver Blade (operate manually)
- 3 Remote signal receptor
- 4 Caster wheels
- 5 Carrying Handles (on each side)

Rear

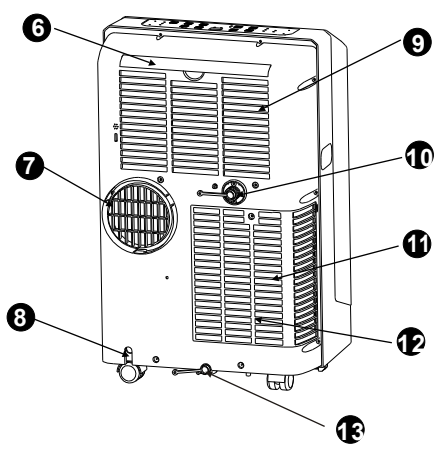

Fig.3

- 6 Upper Air Filter (Behind the grille)
- 7 Air Outlet
- 8 Power cord outlet
- 9 Air intake
- 10 Drain Outlet
- 11 Air intake
- 12 Lower Air Filter (Behind the grille)
- 13 Bottom tray drain outlet

AIR CONDITIONER FEATURES

ELECTRONIC CONTROL OPERATING INSTRUCTIONS

Before you begin, thoroughly familiarize yourself with the control panel and remote controller and all its functions, then follow the symbols for the functions you desire.

The unit can be controlled by the unit control panel itself with the remote control.

NOTE: This manual does not include Remote Controller Operations, see the <<Remote Controller Instruction>> packed with the unit for details.

OPERATION PANEL OF THE AIR CONDITIONER

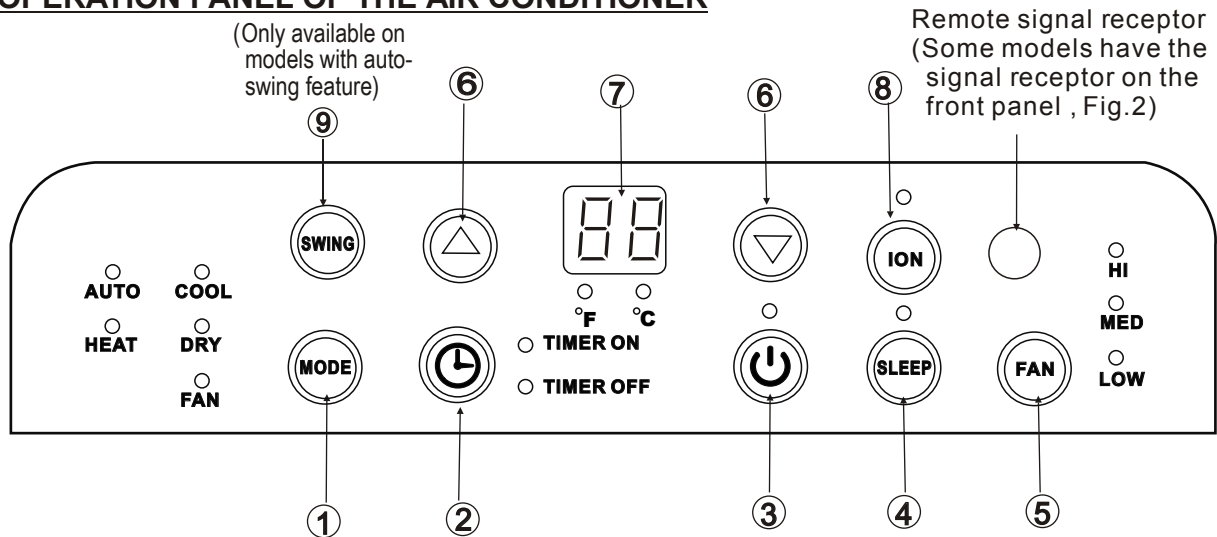

Fig.4

① MODE select button

Selects the operating mode. Each time you press the button, the mode cycles through the following sequence: AUTO, COOL, DRY, FAN and HEAT(not available on cooling only models). The mode indicator light illuminates according to the mode selected.(Fig.4.)

② TIMER button

Used to initiate the AUTO ON start time and AUTO OFF stop time program, in conjunction with the \triangle & ∇ buttons.

③ POWER button

Power switch on/off.

④ SLEEP button

Used to initiate the SLEEP mode.

⑤ FAN button

Controls the fan speed. Press to select the fan speed in four steps-LOW, MED, HI and AUTO. The fan speed indicator light illuminates the corresponding fan settings except AUTO. On AUTO fan speed, all fan indicator lights will be off.

⑥ UP(\triangle) and DOWN(∇) button

Used to adjust (increasing/decreasing) temperature settings(one degree increments) in a range of 17°C(62°F) to 30°C(88°F) or the TIMER setting.

NOTE: The control is capable of displaying temperature in Fahrenheit or Celsius. To convert from one to the other, press and hold the Up and Down buttons at the same time, for 3 seconds.

⑦ LED Display

Shows the set temperature in " °C" or " °F" and the Auto-timer settings. While on DRY and FAN modes, it shows the room temperature.

Error codes and protection code:

- E1-** Room temperature sensor error-
Unplug the unit and plug it back in.
If error repeats, call for service.
- E2-** Evaporator temperature sensor error-
Unplug the unit and plug it back in.
If error repeats, call for service.
- E4-** Display panel communication error-
Unplug the unit and plug it back in.
If error repeats, call for service.
- P1-** Bottom tray is full - Connect the drain hose and empty the collected water. If error repeats, call for service.

OPERATING INSTRUCTIONS

③ ION button(optional)

Press the ION button, to activate the ion generator which will help to remove pollen and impurities from the air, and trap them in the filter. Press again to stop.

⑨ SWING button

(Applicable to the models with auto swing feature only)

Press to change the louver angle. Press and hold the button to initiate the Auto-Swing feature.

Operating Instructions

COOL mode

- Press the "MODE" button until the "COOL" indicator light comes on.
- Press the UP or DOWN arrow buttons "▲" or "▼" to select your desired room temperature. The temperature can be set within a range of 17°C-30°C/62°F-88°F.
- Press the "FAN SPEED" button to change the fan speed.

HEAT mode (not available on cooling only models)

- Press the "MODE" button until the "HEAT" indicator light comes on.
- Press the UP or DOWN arrow buttons "▲" or "▼" to select your desired room temperature. The temperature can be set within a range of 17°C-30°C/62°F-88°F.
- Press the "FAN SPEED" button to change the fan speed. For some models, the fan speed can not be adjusted under HEAT mode.

DRY mode

- Press the "MODE" button until the "DRY" indicator light comes on.
- In this mode, you cannot change the fan speed or adjust the temperature. The fan motor operates at LOW speed.
- Keep windows and doors closed for the best dehumidifying effect.
- Do not put the duct to window.

AUTO mode

- When you set the air conditioner in AUTO mode, it will automatically select cooling, heating(only on cooling only models), or fan only operation depending on the temperature you have selected and the current room temperature.

*** Self Evaporation System works in COOL mode only**

- The air conditioner will automatically control room temperature around the temperature point you set.
- In AUTO mode, fan speed cannot be changed.

FAN mode

- Press the "MODE" button until the "FAN" indicator light comes on.
- Press the "FAN SPEED" button to choose the fan speed. The temperature settings cannot be adjusted.
- Do not put the duct to window.

TIMER mode

- While the unit is on, press the Timer button, the TIMER OFF indicator light illuminates. This indicates the Auto Stop program is initiated.
- While the unit is off, first press the Timer button, the TIMER ON indicator light illuminates. This indicates the Auto Start program is initiated.
- Press or hold the UP or DOWN button to change the Auto time by half an hour increments, up to 10 hours, then at 1 hour increments up to 24 hours. The control will count down the time remaining until start.
- The selected time will register in 5 second and the system will automatically revert back to display the previous temperature setting.
- Turning the unit ON or OFF at any time or adjusting the timer setting to 0.0 will cancel the Auto Start/ Stop program.
- If a malfunction (E1 or E2) occurs, the Auto Start/Stop program will also be cancelled.

SLEEP mode

In SLEEP mode, the selected temperature will increase(cooling) or decrease(heating) by one degree every 30 minutes. The temperature will increase(cooling) or decrease(heating) by another one degree for an additional 30 minutes. This new temperature will be maintained for 7 hours before it returns to the originally selected temperature. This ends the Sleep mode and the unit will continue to operate as originally programmed.

NOTE: This feature is unavailable in FAN or DRY mode.

Other features

Auto-Restart(only on some models)

If the unit shuts off unexpectedly due to power outage, it will resume with the previous operation automatically when the power comes back on.

Wait 3 minutes before resuming operation

After the unit has been turned off, it cannot be restarted immediately. This is to protect the unit from malfunction. Operation will automatically restart after 3 minutes have passed.

Air flow direction adjustment

The louver can be adjusted manually or automatically depending on the model.

• Adjust the air flow direction manually (Fig.5):

- The louver can be set to the desired position manually. The max setting angle is about 60° , please do not force it to open beyond the maximum angle.
- Do not place any heavy objects on the louver, doing so will cause damage to the unit.
- **Ensure the louver is fully opened during heating operation.**

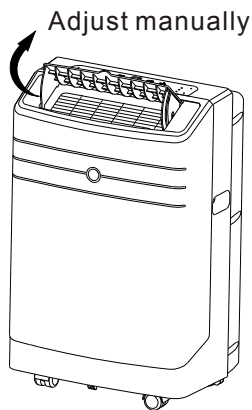

Fig.5

• Adjust the air flow direction automatically (Fig.6):

- When the unit is turned ON, the louver opens fully. Use the SWING button on the remote control to adjust the louver to the desired angle.
- The louver moves at an angle of 6° for each press until it is at maximum angle at which point it changes swing direction.
- Holding down the SWING button more than 2 seconds activates the Auto swing feature. (Fig.6)

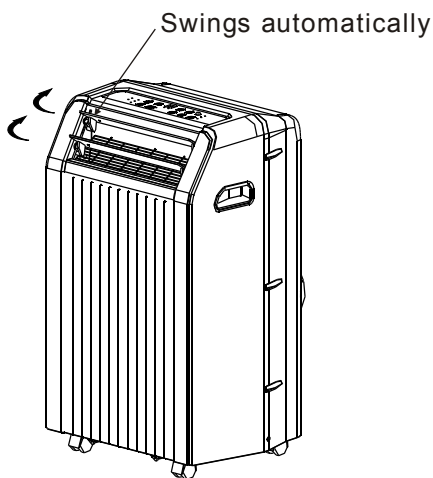

Fig.6

INSTALLATION INSTRUCTIONS

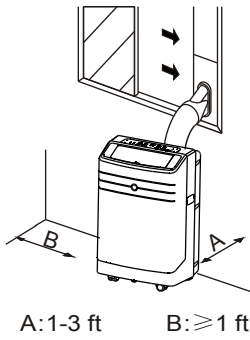
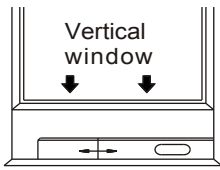

Fig.7



Window Slider Kit
Minimum: 26.5 in. (2.22ft).
Maximum: 48.4 in. (4.04ft).

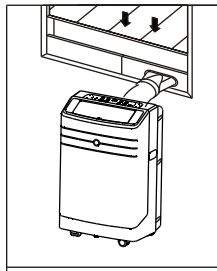
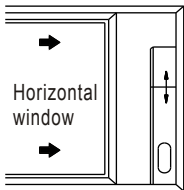

Fig.8



Window Slider Kit
Minimum: 26.5 in. (2.22ft).
Maximum: 48.4 in. (4.04ft).

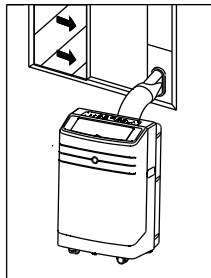

Fig.9

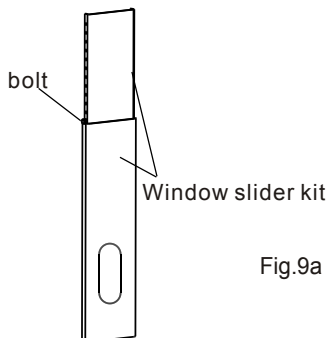

Fig.9a

INSTALLATION INSTRUCTIONS

Placement

- The air conditioner should be placed on a firm foundation to minimize noise and vibration. For safe and secure placement, place the unit on a smooth, level floor.
- The unit has casters for easy mobility, but it should only be rolled on smooth, flat surfaces. Use caution when rolling on carpet surfaces. Do not attempt to roll the unit over objects.
- The unit must be placed within reach of a properly grounded socket.
- Never place any obstacles around the air inlet or outlet of the unit.
- Allow 1 ft. to 3.3 ft. of space from the wall to the window for efficient air-conditioning.

Window Slider kit Installation

Your window slider kit has been designed to fit most standard "vertical" and "horizontal" window applications. However, it may be necessary for you to improvise/modify some aspects of the installation procedures for certain types of window. Please refer to Fig. 8 & Fig.9 for minimum and maximum window openings. Window slider kit can be fixed with a bolt (see Fig.9a).

Note: If the window opening is less than the recommended minimum length of the window slider kit, make a hole to fit the window opening. Never cut the hole out of the window slider kit.

INSTALLATION INSTRUCTIONS

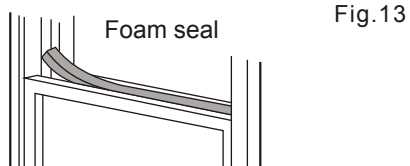
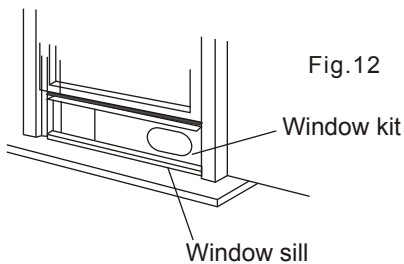
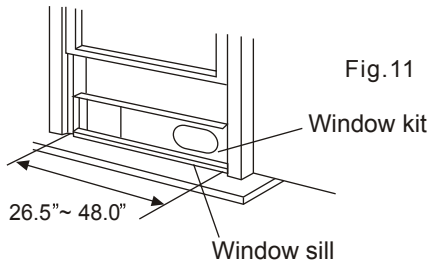
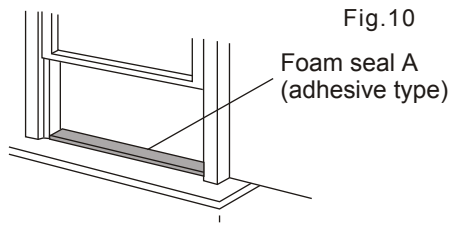

Installation in a double-hung sash window

1. Cut the foam seal(adhesive type) to the proper length and attach it to the window sill. Fig.10
2. Attach the window slider kit to the window seal. Adjust the length of the window slider kit according to the width of window, shorten the adjustable window kit if the width of window is less than 26.5 inches. Open the window sash and place the window slider kit on the window sill. See Fig.11.
3. Cut the foam seal(adhesive type) to the proper length and attach it on the top of the window. Shown as in Fig.12.
4. Close the window sash securely against the window.
5. Cut the foam seal to an appropriate length and seal the open gap between the top window sash and outer window sash. Shown as in Fig.13.

INSTALLATION INSTRUCTIONS

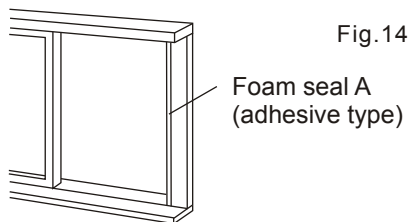

Installation in a sliding sash window

1. Cut the foam seal(adhesive type) to the proper length and attach it to the window frame, Fig. 14.

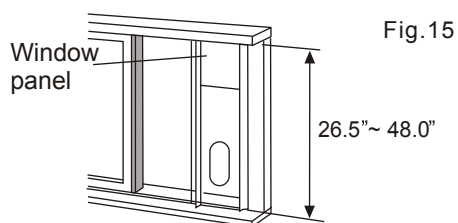

2. Attach the window slider kit to the window sill. Adjust the length of the window slider kit according to the width of window, shorten the adjustable window kit if the width of window is less than 26.5 inches. Open the window sash and place the window slider kit on the window sill. See Fig. 15.

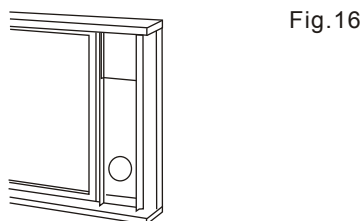

3. Cut the foam seal(adhesive type) to the proper length and attach it on the top of the window. Shown as in Fig. 16.

4. Close the sliding sash securely against the window.

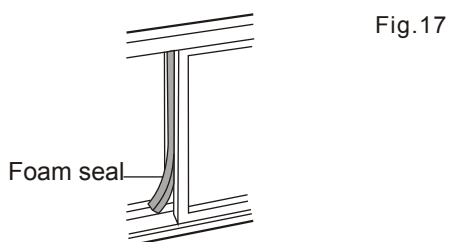

5. Cut the foam seal to an appropriate length and seal the open gap between the top window sash and outer window sash. Shown as in Fig. 17.

INSTALLATION INSTRUCTIONS

NOTE: Please seal the white foam seal (supplied) between the window kit and the window sill when there is the gap between them as shown below:

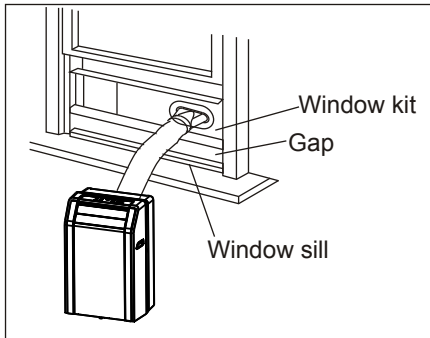

(Fig.A)

Seal the white foam seal

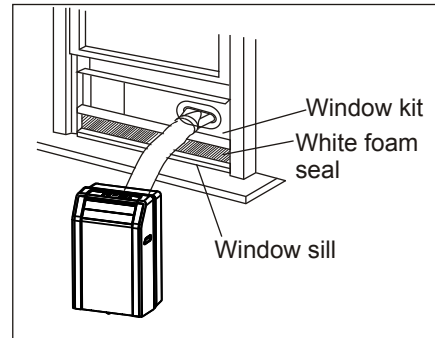

(Fig.A1)

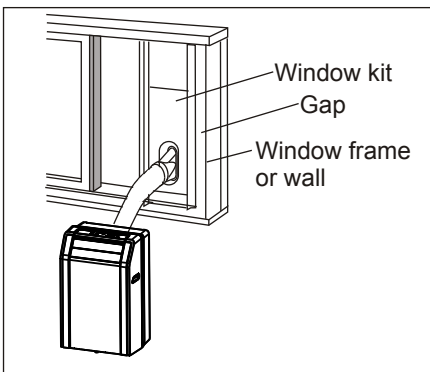

(Fig.B)

Seal the white foam seal

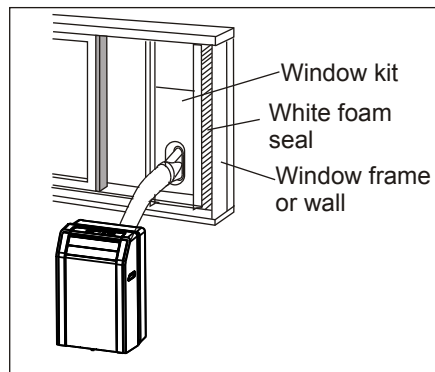

(Fig.B1)

INSTALLATION INSTRUCTIONS

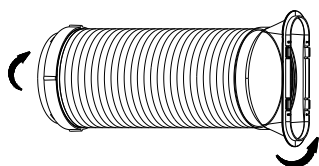

Fig.18

Exhaust hose installation:

The exhaust hose and adaptor must be attached or removed in accordance with the usage mode.

COOL,HEAT(heat pump type) or AUTO mode	Attach
FAN, DEHUMIDIFY or HEAT(electrical heat type) mode	Remove

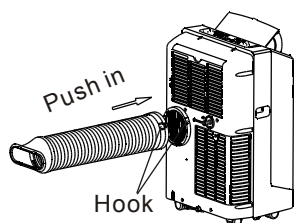

Fig.19

1. Install the window Exhaust adaptor B onto the exhaust hose as shown in Fig.18. Refer to the previous pages for window kit installation.

2. Place the Exhaust hose over against the air outlet opening hook(See Fig.19) and flat the other end(See Fig.20) for quick installation.

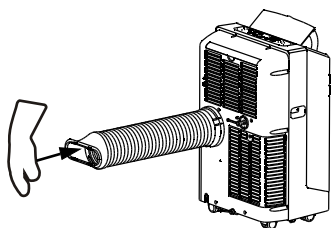

Fig.20

Note:

Cover the hole using the adaptor cap when not in use.

- The duct can be compressed or extended moderately according to the installation requirement, but it is desirable to keep the duct length to a minimum.

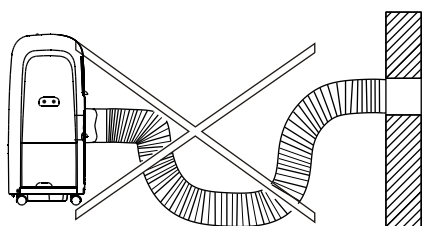

Fig.21

IMPORTANT:

DO NOT OVER BEND THE DUCT (SEE Fig.21)

⚠ CAUTION:

Make sure that there is no obstacle around the air outlet of the exhaust hose (in the range of 1.6 ft.) in order to the exhaust system works properly.

INSTALLATION INSTRUCTIONS

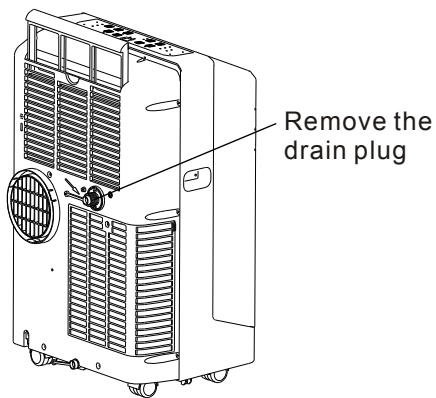

Fig.22

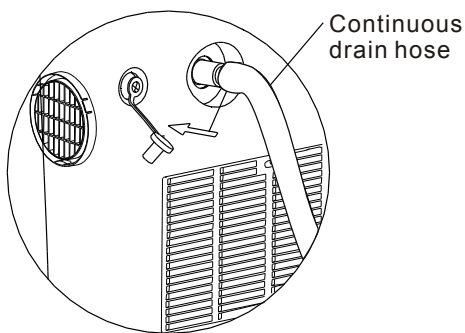

Fig.23

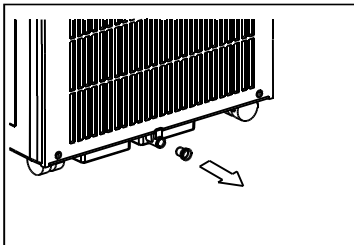

Fig.24

Water drainage:

- During dehumidifying modes, remove the drain plug from the back of the unit, install the drain connector(5/8" universal female mender) with 3/4" hose(locally purchased). For the models without drain connector, just attach the drain hose to the hole. Place the open end of the hose directly over the drain area in your basement floor. Please refer to Fig.22 & 23.

- When the water level of the bottom tray reaches a predetermined level, the unit beeps 8 times, the digital display area shows "P1". At this time the air conditioning/dehumidification process will immediately stop. However, the fan motor will continue to operate(this is normal). Carefully move the unit to a drain location, remove the bottom drain plug and let the water drain away(Fig.24). Restart the machine and wait for the "P1" symbol to disappear. If the error continues, call for service.

NOTE: Be sure to reinstall the bottom drain plug before using the unit.

CARE AND MAINTENANCE

IMPORTANT:

- 1) Be sure to unplug the unit before cleaning or servicing.
- 2) Do not use gasoline, thinner or other chemicals to clean the unit.
- 3) Do not wash the unit directly under a tap or using a hose. It may cause electrical danger.
- 4) If the power cord is damaged, it should be repaired by customer service or the manufacturer.

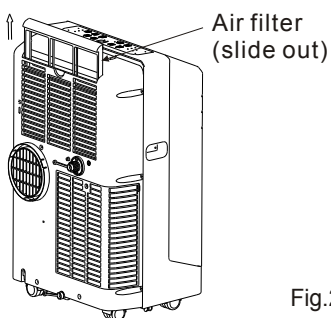

Fig.25

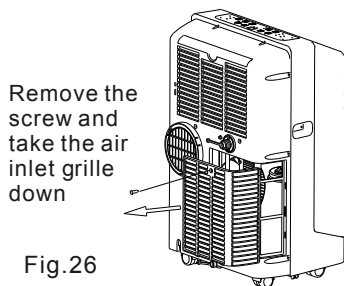
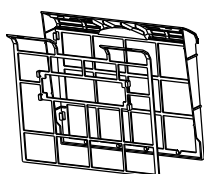

Fig.26



Remove the air filter out from the grille

Fig.27

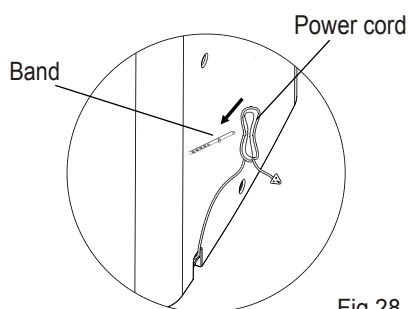

Fig.28

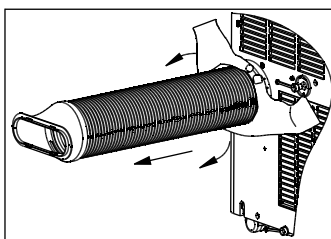

Fig.29

1. Air filter

- Clean the air filter at least once every two weeks to prevent degrading fan operation because of dust.
- Removal
This unit has two filters. Grasp the upper filter tab(Fig.25), pull the filter "out" then "up". Remove the lower filter by loosening the screw, taking down the air inlet grille, then removing the air filter as shown in Fig.26 & 27.
- Cleaning
Wash the air filter by immersing it gently in warm water with a neutral detergent. Rinse the filter and dry in a shady place.
- Mounting
Reinsert the upper air filter from the top after cleaning, attach the lower air filter on the air inlet grille, then install the grille by using the screw.

2. Unit enclosure

- Use a lint-free cloth soaked in neutral detergent to clean the unit enclosure. Finish with a dry clean cloth.

3. Unit idle for a long time

- Remove the rubber plug at the back of the unit and attach a hose to drain outlet. Place the open end of the hose directly over a drain or separate container to dispose of later (See Fig.22 & 23).
- Remove the plug from the bottom drain outlet, all the water in the bottom tray should drain out (See Fig.24).
- Keep the appliance running on FAN mode for half a day in a warm room to dry the appliance inside and prevent mold forming.
- Stop the appliance and unplug it, wrapped the cord and bundle it with the tape(Fig.28). Remove the batteries from the remote controller.
- Clean the air filter and reinstall it.
- Unscrew the exhaust hose to the right or left and pull out to detach(Fig.29), keep it safety, and cover the window (wall) hole with the adaptor cap.

TROUBLESHOOTING TIPS

TROUBLE SHOOTING

PROBLEM	SOLUTION
1. Unit does not start when pressing ON/OFF button	- P1 appears in the display window. Drain the water in the bottom tray.
	- Room temperature is lower than the set temperature.(Cooling mode) Reset the temperature.
2. Not cool enough	- The windows or doors in the room are not closed. Make sure all the windows and doors are closed.
	- There are heat sources inside the room. Remove the heat sources if possible.
	- Exhaust air duct is not connected or blocked. Connect the duct and make sure it can function properly.
	- Temperature setting is too high. Decrease the set temperature.
3. Noisy or vibration	- Air filter is blocked by dust. Clean the air filter.
	- The ground is not level or not flat enough. Place the unit on a flat, level ground if possible.
4. Gurgling sound	- The sound comes from the flowing of the refrigerant inside the air-conditioner. This is normal.
5. Power shut off at Heating mode	- The automatic over heat protection function. When the temperature at the air outlet exceeds 70°C/158°F,the device will stop. Switch on again after the unit has cool down.

NOTE

The rating data indicated on the energy label is based on the testing condition of installing the un-extended air exhaust duct without adaptor A & B (The duct and the adaptor A & B are listed in the accessories chart of the Instruction Manual).

