

# MAGNAVOX

## OWNER'S MANUAL

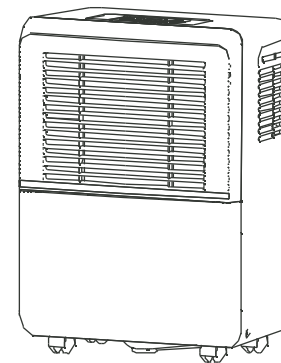

MODEL: D-40ES

The design and specifications are subject to change without prior notice for product improvement. Consult with the sales agency or manufacturer for details.

MAGNAVOX and SMART. VERY SMART are registered trademarks of Koninklijke Philips N.V. and are used under license from Koninklijke Philips N.V.

**For any service needs, call 1-855-368-8606**

Before operating this product, please read the instructions carefully and save this manual for future use.

# CONTENTS

## SAFETY PRECAUTIONS

Warning .....	2
Caution .....	2
Electrical information .....	3

## DEHUMIDIFIER CONTROL PANEL

Control panel .....	4
Other features .....	5

## PARTS IDENTIFICATION

Parts identification .....	6
Placing the unit .....	7

## UNIT OPERATION

Before operating unit .....	7
Removing the collected water .....	8

## CARE AND MAINTENANCE

Cleaning and care .....	9
-------------------------	---

## TROUBLESHOOTING TIPS

Troubleshooting tips .....	10
----------------------------	----

## Read This Manual

Inside you will find many helpful hints on how to use and maintain your appliance properly. Just a little preventive care on your part can save you a great deal of time and money over the life of your unit. You'll find many answers to common problems in the Troubleshooting Tips section (page10).



### CAUTION

- This appliance is not intended for use by children or persons with reduced physical sensory or mental capabilities unless they are supervised by a responsible adult or considered capable enough to operate the appliance safely.
- Children should be supervised to ensure that they do not play with the appliance.
- If the supply cord is damaged, it must be replaced by the manufacturer, its service agent or similarly qualified persons in order to avoid a hazard.
- The appliance shall be installed in accordance with national wiring regulations.
- The appliance with electric heater should not be around combustible materials.
- Contact the authorised service technician for repair or maintenance of this unit.

# SAFETY PRECAUTIONS

To prevent injury to the user or other people and property damage, the following instructions must be followed. Incorrect operation may cause harm or damage.











- The seriousness is classified by the following symbols.

 <b>WARNING</b>	This symbol indicates the possibility of death or serious injury.
 <b>CAUTION</b>	This symbol indicates the possibility of injury or damage to property.



- Please be advised when you see the following symbols.

	<b>Never do this.</b>
	<b>Always do this.</b>

### WARNING

- |  |   |  |
|--|---|--|
| <p> <b>Do not exceed the rating of the power outlet or connection device.</b></p> <ul style="list-style-type: none"> <li>• Otherwise, it may cause electric shock or fire due to excess heat generation.</li> </ul> | <p> <b>Do not operate or stop the unit by switching on or off the power.</b></p> <ul style="list-style-type: none"> <li>• It may cause electric shock or fire due to heat generation.</li> </ul> | <p> <b>Do not damage or use an unspecified power cord.</b></p> <ul style="list-style-type: none"> <li>• It may cause electric shock or fire.</li> </ul>                       |
| <p> <b>Do not modify power cord length or share the outlet with other appliances</b></p> <ul style="list-style-type: none"> <li>• It may cause electric shock or fire due to heat generation.</li> </ul>            | <p> <b>Do not insert or pull out plug with wet hands.</b></p> <ul style="list-style-type: none"> <li>• It may cause electric shock.</li> </ul>   | <p> <b>Do not place the unit near a heat source.</b></p> <ul style="list-style-type: none"> <li>• Plastic parts may melt and cause a fire.</li> </ul>                         |
| <p> <b>Disconnect the power if strange sounds, smell, or smoke comes from it.</b></p> <ul style="list-style-type: none"> <li>• It may cause fire and electric shock.</li> </ul>                                     | <p> <b>You should never try to take apart or repair the unit by yourself.</b></p> <ul style="list-style-type: none"> <li>• It may cause failure of machine or electric shock.</li> </ul>         | <p> <b>Before cleaning, turn off the power and unplug the unit.</b></p> <ul style="list-style-type: none"> <li>• It may cause electrical shock or injury.</li> </ul>          |
| <p> <b>Do not use the machine near flammable gas or combustibles, such as gasoline, benzene, thinner, etc.</b></p> <ul style="list-style-type: none"> <li>• It may cause an explosion or fire.</li> </ul>         | <p> <b>Do not drink or use the water drained from the unit.</b></p> <ul style="list-style-type: none"> <li>• It contains contaminants and could make you sick.</li> </ul>                      | <p> <b>Do not take the water bucket out during operation.</b></p> <ul style="list-style-type: none"> <li>• It may cause water to spill and cause electric shock.</li> </ul> |

### CAUTION

- |  |   |  |
|--|---|--|
| <p> <b>Do not use the unit in small spaces.</b></p> <ul style="list-style-type: none"> <li>• Lack of ventilation can cause overheating and fire.</li> </ul> | <p> <b>Do not put in places where water may splash onto the unit.</b></p> <ul style="list-style-type: none"> <li>• Water may enter the unit and degrade the insulation. It may cause an electric shock or fire.</li> </ul> | <p> <b>Place the unit on a level, sturdy section of the floor.</b></p> <ul style="list-style-type: none"> <li>• If the unit falls over, it may cause water to spill and damage belongings or cause electrical shock or fire.</li> </ul> |
|--|---|--|

## SAFETY PRECAUTIONS

### ⚠ CAUTION

- |   |   |   |
|---|---|---|
| <p>❗ Do not cover the intake or exhaust openings with cloths or towels.</p> <ul style="list-style-type: none"> <li>A lack of air flow can lead to overheating and fire.</li> </ul>  | <p>❗ Care should be taken when using the unit in a room with the following persons:</p> <ul style="list-style-type: none"> <li>Infants, children, elderly people, and people not sensitive to humidity.</li> </ul>      | <p>❗ Do not use in areas where chemicals are handled.</p> <ul style="list-style-type: none"> <li>This will cause the unit deterioration due to chemicals and solvents dissolved in the air.</li> </ul>                      |
| <p>❗ Never insert your finger or other foreign objects into grills or openings. Take special care to warn children of these dangers.</p> <ul style="list-style-type: none"> <li>It may cause electric shock or failure of appliance.</li> </ul> | <p>❗ Do not place heavy object on the power cord and take care so that the cord is not compressed.</p> <ul style="list-style-type: none"> <li>There is danger of fire or electric shock.</li> </ul>                     | <p>❗ Do not climb up on or sit on the unit.</p> <ul style="list-style-type: none"> <li>You may be injured if you fall or if the unit falls over.</li> </ul>   |
| <p>❗ Always insert the filters securely. Clean filter once every two weeks.</p> <ul style="list-style-type: none"> <li>Operation without filters may cause failure.</li> </ul>  | <p>❗ If water enters the unit, turn the unit off and disconnect the power, contact a qualified service technician.</p> <ul style="list-style-type: none"> <li>It may cause failure of appliance or accident.</li> </ul> | <p>❗ Do not place flower vases or other water container on top of the unit.</p> <ul style="list-style-type: none"> <li>Water may spill inside the unit, causing insulation failure and electrical shock or fire.</li> </ul> |

## Electrical Information

- The manufacturer's nameplate is located on the rear panel of the unit and contains electrical and other technical data specific to this unit.
- Be sure the unit is properly grounded. To minimize shock or fire hazards, proper grounding is important. The power cord is equipped with a three-prong grounding plug for protection against shock hazards.
- Your unit must be used in a properly grounded wall receptacle. If the wall receptacle you intend to use is not adequately grounded or protected by a time delay fuse or circuit breaker, have a qualified electrician install the proper receptacle.
- Ensure the receptacle is accessible after unit installation.
- Do not use extension cords or an adapter plugs with this unit.** However, if it is necessary to use an extension cord, use an approved "Dehumidifier" extension cord only (available at most local hardware stores).
- To avoid the possibility of personal injury, always disconnect the power supply to the unit before installing and/or servicing.

3

## DEHUMIDIFIER CONTROL PANEL

**NOTE:** The control panel of the unit you purchased may be slightly different depending on the model.

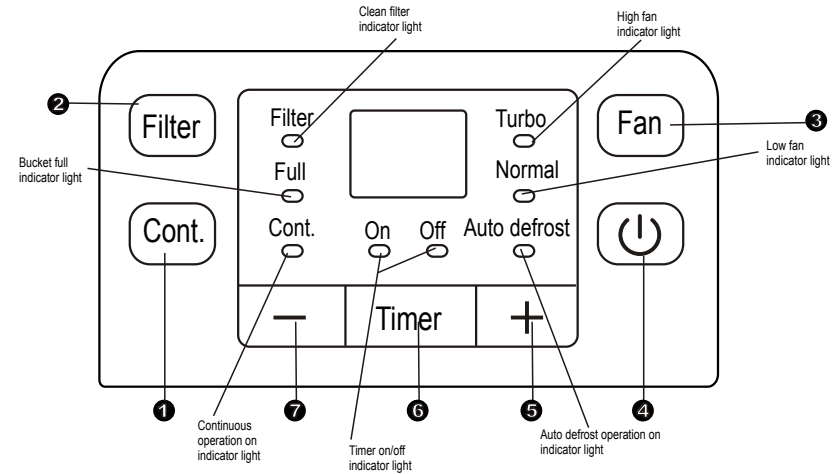

Fig. 1

## Control panel

When you push the button to change operation modes, the unit will make a beep sound to indicate mode change.

- 1 Continuous button**  
Press to activate the continuous dehumidifying operation.
- 2 Filter button**  
The check filter feature is a reminder to clean the Air Filter for more efficient operation. The Filter light (Clean filter light) will illuminate after 250 hours of operation. To reset after cleaning the filter, press the Filter pad and the light will go off.
- 3 Fan button**  
Control the fan speed. Press to select either High or Normal fan speed. Set the fan control to High for maximum moisture removal. When the humidity has been reduced and quiet operation is preferred, set the fan control to Normal.
- 4 Power button**  
Press to turn the dehumidifier on and off.
- 5 7 +/− : Down/Up Buttons**
  - Humidity Set buttons**  
The humidity level can be set within a range of 35%RH (Relative Humidity) to 85%RH (Relative Humidity) in 5% increments.  
For drier air, press the − pad and set to a lower percent value(%).  
For damper air, press the + pad and set a higher percent value(%).
  - \* When adjusting humidity levels, the CONTINUOUS OPERATION INDICATOR LIGHT MUST BE OFF**
  - TIMER Set buttons**  
Use the Up/Down buttons to set the Auto start and Auto stop time from 0.0 to 24.
  - 6 Timer button**  
Press to initiate the Auto start and Auto stop feature, in conjunction with the + and − key buttons.

4

## DEHUMIDIFIER CONTROL PANEL

### ⑩ Display

Shows the set % humidity level from 35% to 85% or auto start/stop time (0~24) while setting, then shows the actual ( $\pm 5\%$  accuracy) room % humidity level in a range of 30% RH(Relative Humidity) to 90%RH(Relative Humidity).

#### Error Codes and Protection Code:

**AS-** Humidity sensor error--Unplug the unit and plug it back in. If error repeats, call for service.

**ES-** Temperature sensor error-- Unplug the unit and plug it back in. If error repeats, call for service.

**P2-** Bucket is full or bucket is not in right position-- Empty the bucket and replace it in the right position.

**P1-** Unit has frost build up-- Allow the unit to run on AUTO DEFROST mode.

**EC-** Unit malfunction--Please make sure whether the environment temperature is suitable for the stated temperature in the manual or not. If not, please operate the unit under the stated temperature. If the environment temperature is normal for the stated temperature, please call for service.

## Other features

### Bucket Full Light

Glowes when the bucket is ready to be emptied, or when the bucket is removed or not placed in the proper position.

### Auto Shut Off

The dehumidifier shuts off after 30 seconds when the bucket is full, or when the bucket is removed or not placed in the proper position. When the set humidity is reached, the unit will shut off automatically. For some models, the fan motor will continue operating.

### Auto Defrost

When frost builds up on the evaporator coils, the compressor will cycle off and the fan will continue to run until the frost disappears.

### Wait 3 minutes before resuming operation

After the unit has stopped, it can not be restarted immediately. This is to protect the unit from malfunction. Operation will automatically start after 3 minutes.

### Check filter feature

The system starts to count the time once the fan motor operates. The check filter feature will be lit when the accumulated operation time achieves 250 hours or more. The Reset light(Clean filter indicator light) flashes until the filter is cleaned. Press the Filter button to reset and stop the blinking filter and Reset light(Clean filter indicator light).

### Auto-Restart

If the unit shuts off unexpectedly due to a power outage, it will restart with the previous function setting automatically when the power resumes.

### Setting the Timer

- When the unit is on, first press the TIMER button, the TIMER OFF indicator light illuminates. It indicates the Auto Stop program is initiated. Press it again for the TIMER ON indicator light to come on to indicate the Auto Start is initiated.
- When the unit is off, first press the Timer button for the TIMER ON indicator light to come on to indicate the Auto Start program. Press again to stop the Timer and initiate Auto Stop.
- Press or hold the UP or DOWN buttons to change the Auto timer by half hour increments, up to 10 hours, then at 1 hour increments up to 24 hours. The control will count down the time remaining until the start time.
- The selected time will register in 5 seconds and the system will automatically revert back to display the previous humidity setting.
- When the Auto start & Auto stop times are set, within the same program sequence, TIMER ON OFF indicator lights both turn on to show that the TIMER ON and OFF program is active.
- Turning the unit ON or OFF at any time or adjusting the timer setting to 0.0 will cancel the Auto Start/Stop function.
- When LED display window displays the code P2, the Auto Start/Stop function will also be cancelled.

## PARTS IDENTIFICATION

### Parts identification

#### Front

- ① Control panel
- ② Air intake grille
- ③ Air outlet grille
- ④ Air filter (behind the grille)
- ⑤ Water bucket
- ⑥ Handle (both sides)

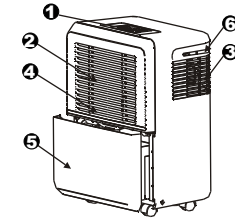

Fig.2

#### Rear

- ① Drain hose outlet
- ② Caster wheels
- ③ Power Cord and plug
- ④ Band(Used only when storing the unit.)

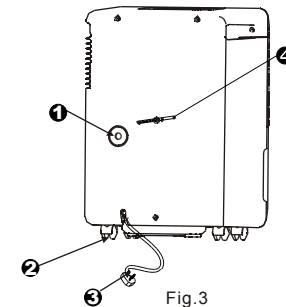

Fig.3

**NOTE:** All pictures in the manual are for explanation purposes only. The actual design of your unit may be slightly different, but the operations and functions are the same.

### Accessories:

Drain hose(1pc)



Screw(2pc)



Adapter A(1pc)

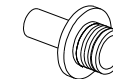

## UNIT OPERATION

### Placing the unit

A dehumidifier operating in a basement will have little or no effect in drying an adjacent enclosed storage area, such as a closet, unless there is adequate circulation of air in and out of the area.

- Do not use outdoors.
- This dehumidifier is intended for indoor residential applications only. This dehumidifier should not be used for commercial or industrial applications.
- Place the dehumidifier on a smooth, level floor strong enough to support the unit with a full bucket of water.
- Allow at least 7.9 in. of air space on all sides of the unit for good air circulation.
- Place the unit in an area where the temperature will not fall below 5°C(41°F). The coils can become covered with frost at temperatures below 5°C(41°F), which may reduce performance.
- Place the unit away from the clothes dryer, heater or radiator.
- Use the unit to prevent moisture damage anywhere books or valuables are stored.
- Use the dehumidifier in a basement to help prevent moisture damage.
- The dehumidifier must be operated in an enclosed area to be most effective.
- Close all doors, windows and other outside openings to the room.

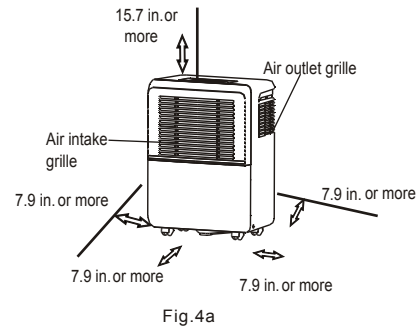

Fig.4a

#### Casters wheels(on the bottom of unit)

- Casters wheels can move freely.
- Do not force casters to move over carpet, nor move the unit with water in the bucket. (The unit may tip over and spill water.)

### When using the unit

- When first using the dehumidifier, operate the unit continuously for 24 hours.
- This unit is designed to operate in a working environment between 5°C/41°F and 35°C/95°F.
- If the unit has been switched off and needs to be switched on again, allow approximately three minutes for the unit to resume normally.
- Do not connect the dehumidifier to a multiple socket outlet, which is also being used for other electrical appliances.
- Select a suitable location, making sure you have easy access to an electrical outlet.
- Plug the unit into a electrical socket-outlet with a grounded connection.
- Make sure the Water bucket is correctly fitted otherwise the unit will not operate properly.

**NOTE:** When the water in the bucket reaches a certain level, please be careful to move the machine to avoid the unit from tipping over.

7

## UNIT OPERATION

### Removing the collected water

There are two ways to remove collected water.

#### 1. Use the bucket

- When the unit is off, if the bucket is full, the unit will beep 8 times and the Full indicator light will flash, the digital display shows P2.
- When the unit is on, if the bucket is full, the compressor turns off and the fan turns off after 30 seconds for drying the water of the condenser, then the unit will beep 8 times and the Full indicator light will flash, the digital display shows P2.
- Slowly pull out the bucket. Grip the left and right handles securely, and carefully pull out straight so water does not spill. Do not put the tank on the floor because the bottom of the bucket is uneven. Otherwise the bucket will fall and cause the water to spill.
- Throw away the water and replace the bucket. The bucket must be in place and securely seated for the dehumidifier to operate.
- The machine will re-start when the bucket is restored in its correct position.

#### NOTES:

- When you remove the bucket, do not touch any parts inside of the unit. Doing so may damage the product.
- Be sure to push the bucket gently all the way into the unit. Banging the bucket against anything or failing to push it in securely may cause the unit not to operate.
- When you remove the bucket, if there is some water in the unit you must dry it.

#### 2. Continuous draining

Water can be automatically emptied into a floor drain by attaching the unit with a water hose (ID ≥ φ5/16, not included) with a female threaded end (ID:M=1", not included).

- Install the drain hose onto the adaptor A (See Fig.7, placed in the bucket).
- Remove the plastic cover from the back drain outlet of the unit and set aside and remove bucket, then insert the drain hose through the drain outlet of the unit and securely press it into the connector on the front of the unit. (See Fig.9)
- Tighten the adaptor A and the unit by using two screws (placed in the bucket).
- Install the female threaded end of the water hose into the adaptor A. (See Fig.10), then lead the water hose to the floor drain or a suitable drainage facility.
- Make sure the hose is secure so there are no leaks.
- Direct the hose toward the drain, making sure that there are no kinks that will stop the water flowing.
- Place the end of the hose into the drain and make sure the end of the hose is level or down to let the water flow smoothly. Do not stop the flow.
- Place the bucket back in the unit and make sure that it is placed correctly.
- Select the desired humidity setting and fan speed on the unit for continuous draining to start.

1. Pull out the bucket a little.

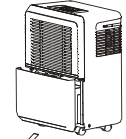

Fig.5

2. Hold both sides of the bucket with even strength and pull it out from the unit.

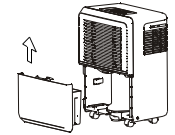

Fig.6

3. Pour the water out.

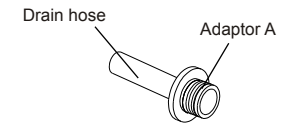

Fig.7

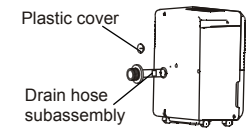

Fig.8

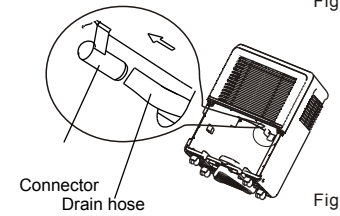

Fig.9

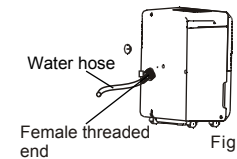

Fig.10

**NOTE:** When the continuous drain feature is not being used, remove the drain hose from the outlet.

8

## CARE AND MAINTENANCE

### Care and cleaning of the dehumidifier

Turn the dehumidifier off and remove the plug from the wall outlet before cleaning.

#### 1. Clean the Grille and Case

- Use water and a mild detergent. Do not use bleach or abrasives.
- Do not splash water directly onto the main unit. Doing so may cause an electrical shock, cause the insulation to deteriorate, or cause the unit to rust.
- The air intake and outlet grilles get soiled easily, so use a vacuum attachment or brush to clean.

#### 2. Clean the bucket

Every few weeks, clean the bucket to prevent growth of mold, mildew and bacteria. Partially fill the bucket with clean water and add a little mild detergent. Swish it around in the bucket, empty and rinse.

**NOTE:** Do not use a dishwasher to clean the bucket. After clean, the bucket must be in place and securely seated for the dehumidifier to operate.

#### 3. Clean the air filter

- Remove the filter every two weeks in normal operating conditions.
- Remove the filter from the top of the unit (See.Fig.11a), or to remove the filter,remove Bucket then pull filter downwards (See.Fig.11b).
- Wash the filter with clean water then dry.
- Re-install the filter, replace Bucket.

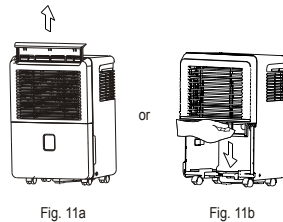

Fig. 11a

Fig. 11b

#### CAUTION:

DO NOT operate the dehumidifier without a filter because dirt and lint will clog it and reduce performance.

#### 4. When not using the unit for long time periods

- Turn off the unit, wait one day before emptying the bucket.
- Clean the main unit, water bucket and air filter.
- Wrap the cord and bundle it with the band(Fig.12) .
- Cover the unit with a plastic bag.
- Store the unit upright in a dry, well-ventilated place.

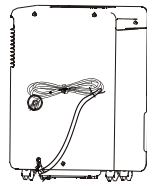

Fig. 12

## TROUBLESHOOTING TIPS

Before calling customer service, review the chart below first yourself.

Problem	What to check
Unit does not start	<ul style="list-style-type: none"> <li>• Make sure the dehumidifier power plug is pushed completely into the power outlet.</li> <li>• Check the house fuse/circuit breaker box.</li> <li>• Dehumidifier has reached its preset level or bucket is full.</li> <li>• Water bucket is not in the proper position.</li> </ul>
Dehumidifier does not dry the air as it should	<ul style="list-style-type: none"> <li>• Did not allow enough time to remove the moisture.</li> <li>• Make sure there are no curtains, blinds or furniture blocking the front or back of the dehumidifier.</li> <li>• The humidity control may not be set low enough.</li> <li>• Check that all doors, windows and other openings are securely closed.</li> <li>• Room temperature is too low, below 5°C(41°F).</li> <li>• There is a kerosene heater or something giving off water vapor in the room.</li> </ul>
The unit makes a loud noise when operating	<ul style="list-style-type: none"> <li>• The air filter is clogged.</li> <li>• The unit is tilted instead of upright as it should be.</li> <li>• The floor surface is not level.</li> </ul>
Frost appears on the coils	<ul style="list-style-type: none"> <li>• This is normal. The dehumidifier has Auto defrost feature.</li> </ul>
Water on the floor	<ul style="list-style-type: none"> <li>• Hose to connector or hose connection may be loose.</li> <li>• Intend to use the bucket to collect water, but the back drain plug is removed.</li> </ul>
ES, AS, P2, or EC appear in the display	<ul style="list-style-type: none"> <li>• These are error codes and protection code. See the DEHUMIDIFIER CONTROL PANEL section.(page 4)</li> </ul>